

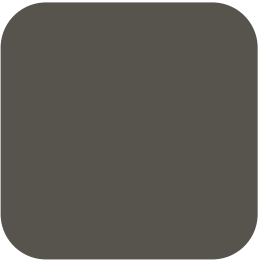

Netball Court Planning Guide



Index

	1. Minister's Foreword 3	7. Netball Court Specifications 17
		7.1 Orientation. 17
	2. Purpose of the Netball Court Planning Guide 4	7.2 Court Size 17
		7.3 Court Layout 17
	3. Case Studies	7.4 Run Off 18
	3.1 Yea Football and Netball Club – Acrylic Court. 5	7.5 Goal Posts. 18
	3.2 South Colac Sports Club – Complete Netball Facility – Layout . . 6	7.6 Goal Rings. 19
	3.3 Minyip Murtoa Football and Netball Club – Court Relocation 7	7.7 Net Post Footings for Fixed or Sleeved Posts 19
	3.4 White Hills Football and Netball Club – Rectifying Proximity to Trees and Court Gradient 8	7.8 Insert Socket Specifications 20
	3.5 Myrtleford Saints Football and Netball Club – Multi-Purpose Courts . . 9	7.9 Padding. 20
	4. Comparison of Different Playing Surfaces 10	7.10 Linemarking. 21
		7.11 Indoor Netball Court Development . 21
	5. Netball Court Development – The Planning Process 14	8. Checklist. 22
	5.1 Consultation 14	9. Acknowledgements. 23
	5.2 Planning Approach 14	
	5.3 Planning Permits. 14	
	5.4 Building Permits 14	
	6. Netball Court Development – Construction and Maintenance . . 15	
	6.1 Items to Consider When Constructing Concrete Bases 15	
	6.2 Maintenance Program for Acrylic Surface Courts 15	
	6.3 Repair Procedures for Acrylic Surface Courts 16	

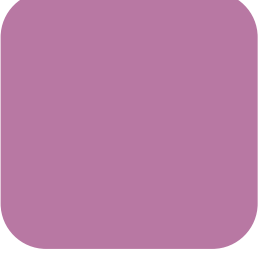
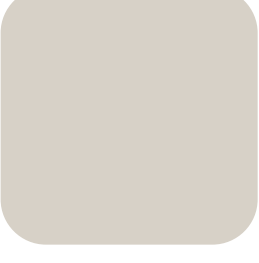
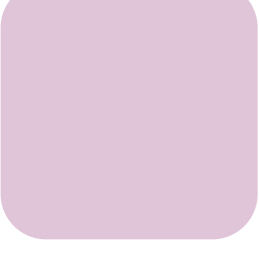
Minister's Foreword

The relationships fostered through participation in netball have helped build stronger ties in communities across Victoria, as well as providing benefits to the health and wellbeing of those who participate.

This *Netball Court Planning Guide* has been developed by the Victorian Government in partnership with Netball Victoria. The Guide aims to help councils, clubs and associations successfully plan and build compliant netball courts to ensure safe participation.

Through the *Country Football and Netball Program* and the *Community Facility Funding Program*, the Victorian Government is funding the improvement of netball facilities across Victoria to meet community needs.

This Guide has been developed to assist communities in using their resources effectively to ensure the successful development or upgrade of netball courts in the future.

This Guide offers practical examples to consider when planning projects and should be read in conjunction with the Victorian Government's *Football and Netball Lighting Guide*, for projects that include a lighting component.

Five case studies are featured to emphasise a range of local issues, budgets and specific technical factors that need to be taken into account when councils, clubs and associations tackle their own projects.

I would also like to acknowledge the clubs that featured in this Guide: Minyip Murtoa Football and Netball Club; Myrtleford Saints Football and Netball Club; South Colac Sports Club; White Hills Football and Netball Club; and Yea Football and Netball Club for their commitment to improving their netball facilities and for working in partnership with their communities.

The Victorian Government is committed to encouraging greater levels of community participation in sport and recreation through our Go For Your Life initiative. I am confident this Guide will help in planning your netball court development and assist you to develop a stronger, healthier community.



A handwritten signature in black ink that reads "James Merlino". The signature is fluid and cursive.

James Merlino MP

Minister for Sport, Recreation
and Youth Affairs

Purpose of the Netball Court Planning Guide

In 2005/2006, the Victorian Government created a partnership with the Australian Football League and each committed \$2 million to the *Country Football and Netball Program*. Soon after the program commenced, as part of the *Moving Forward – Provincial Victoria Statement*, the Victorian State Government invested a further \$6 million, resulting in a total pool of \$10 million to assist rural and regional councils. The *Country Football and Netball Program* assists country football and netball clubs and umpiring organisations to develop facilities to increase participation opportunities for all Victorians.

In addition, the Victorian Government's *Community Facility Funding Program* helps provide high quality sport and recreation facilities which contribute to community strengthening and promote a healthy lifestyle for all Victorians. The Minor Facilities category in particular provides funding to community groups, working in partnership with council, to develop and upgrade community sport and recreation facilities including netball facilities.

The Netball Court Planning Guide was developed by the Victorian Government, in partnership with Netball Victoria, to assist councils, and netballing organisations to successfully plan and build compliant netball courts.

Five case studies have been developed to highlight examples that showcase a range of project scopes and budgets.

The case studies highlight factors that should be considered when developing or upgrading netball precincts such as; surface type, run-off, multi-use and the positioning of adjacent infrastructure.

Technical information and details of netball court standards are also provided. The publication does not replace these standards, but aims to offer practical examples for communities to consider in planning their own projects. Communities are encouraged to contact Netball Victoria to discuss facility development ideas when planning for projects.

It is envisaged that councils, clubs and associations planning future netball facility upgrades will benefit from the case studies and technical information outlined.



Case Studies – Yea Football and Netball club

Acrylic* court



Club | Yea Football and Netball Club
 Council | Murrindindi Shire Council
 Project Name | Netball Court Extension/Resurfacing
 CFNP Grant | \$13,631
 Total Project Cost | \$20,447 (2007)

Before: concrete netball court in Yea



After: Yea's new acrylic court



The Yea Football and Netball Club has two senior and four junior netball teams. In 2007 the club in collaboration with council undertook a project to extend and resurface their one and only concrete netball court at a cost of \$20,447.

The old concrete surface was deteriorating, slippery in wet conditions and unforgiving to fall on. It also failed to meet netball court standards in relation to court run-off. As a result, the club sought to provide a better quality, safer and more accessible sporting facility for young people and women in the rural township.

The netballers of Yea now have a much improved netball court with an acrylic surface.

“Acrylic surfaces provide better traction than concrete,” explains Leonie Gibson Netball Victoria’s Association Development Administrator.

Acrylic also presents a more comfortable playing environment in hot weather with court temperatures being lower in comparison to asphalt or concrete courts. The anti-glare finish also enhances visibility for players, umpires and spectators alike.

The court dimensions were also extended to meet Netball Victoria requirements with works taking three and a half months to complete.

The project was supervised by a Steering Committee comprising of the Yea Football and Netball Club, the Yea Recreation Reserve Committee of Management and the Murrindindi Shire Council. The club liaised closely with Council in planning the project and developing a grant application.

The court resurfacing has helped strengthen the Club. Jacqui Canton, former Treasurer of the Yea Netball Club, explains that “the project brought us into line with Netball Victoria court standards. Beforehand we couldn’t host finals. Finals are a real boost for the Club and extremely important for its viability.”

By way of advice, Ms Canton states that it is imperative to “make sure you get an experienced firm to do the work. I have heard some horror stories, so I would strongly suggest you get someone who knows what they are doing.”

The project has provided Yea Football and Netball Club with a rejuvenated netball court. “The new surface is much more user friendly, has improved the aesthetics of the reserve, and is much safer for our players to play on,” says Ms Canton.

* An acrylic surface involves the application of multiple layers of acrylic materials (e.g. resin, paint, etc) on a base surface, commonly concrete or asphalt. Acrylic is also referred to by other names such as synthetic, plexipave, synpave and rebound ace.

For more information contact Murrindindi Shire Council on (03) 5772 0333.

Tip:

It is essential to have a good understanding of soil conditions prior to court construction to determine correct court construction requirements. Soil tests should be carried out by a recognised Geo Technical company.

South Colac Sports Club

Complete Netball Facility – Layout



Club | South Colac Sports Club
 Council | Colac Otway Shire Council
 Project Name | Netball Facilities Redevelopment
 CFNP Grant | \$60,000
 Total Project Cost | \$93,824 (2006)

The court under construction at South Colac



“The best netball facilities in the league.” That is the way Ray Quigley, Vice President of the South Colac Sports Club describes the netball facilities at the South Colac Sports Precinct. “Opposition players want to play here every week.” The pride in Ray’s voice is clearly evident as he talks about his club and the facilities they now enjoy. But it wasn’t always the case...

Over previous years the club’s netball players, parents and spectators regularly complained about the club’s netball facilities, or lack of them. A lack of court drainage meant that games were regularly transferred to other venues after overnight rains. With one small shelter being shared by players, coaches, officials, parents and spectators, people were reluctant to become involved in netball. “We were doing all we could just to keep the court playable,” said Ray. “If the weather was wet and windy no one wanted to be there.”

Ray partnered with council in planning for the project or as he puts it, “Doing his homework.” Ray’s “homework” consisted of consulting with club and Committee members, seeking advice from Netball Victoria, seeking quotes from contractors, organising club tradespersons and raising funds for the project.

The project involved repositioning the court in order to obtain adequate court dimensions, installing kerb and channel drainage, court resealing and line marking. The project also involved the development of an amenities building, installation of fencing, a large shelter and paving.

“It was important for us to make the most of our existing facilities in order to make our money stretch as far as possible,” said Ray. The club and council utilised the existing court base, lighting and shelter and by doing so saved several thousands

of dollars. The stakeholders sought to incorporate the new infrastructure into the existing surrounds and make the facilities as functional and user-friendly as possible.

And that’s exactly what they did. The netball amenities building has windows that face onto the court. This allows teams to warm up whilst still keeping an eye on the action. The new shelter extends the length of the court providing protection from the weather, a barrier to stray balls and privacy to the nearby residents. Concrete paving under the shelters and around the court allows participants to easily move in and around the facilities and means the court doesn’t need to be regularly swept of stones. And the position of the court and facilities allows spectators to view the netball and football with ease.

The positioning of facilities creates a mini netball amphitheatre which has enhanced the atmosphere of the games. “People now want to be watching the netball and are happy to volunteer for time keeping or whatever the job may be,” says Ray. “The footballers who would rarely watch the netball, now come over to support the girls. “It’s brought the club together,” says Ray. “Netball is no longer the poorer cousin, we’re half the club!”

For more information contact Colac Otway Shire Council on (03) 5232 9400.

Tip:

Courts must have adequate surface and perimeter drainage via spoon drains and Ag drains around the court. These should discharge away from the court via a drainage pit in the low corner.

The new facilities at South Colac



Minyip Murtoa Football and Netball Club

Court Relocation



Club | Minyip Murtoa Football and Netball Club
 Council | Yarriambiack Shire Council
 Project Name | Minyip Murtoa Football and Netball Club
 Netball Court Extension
 CFNP Grant | \$11,234
 Total Project Cost | \$26,650 (2006)



Before: the old asphalt court



It's 8am on a Winter's Saturday morning. Football and netball club volunteers throughout Victoria are hard at work preparing for a day full of football and netball matches. They are the heartbeat of clubs. Their work goes largely unnoticed, but without these committed few many of us would be unable to enjoy football and netball as we know it.

With the help of a grader blade Brian Storey was able to smooth out the surface and allow for the required fall. The hot mix was laid, line marking took place and finally the court was ready for play once again.

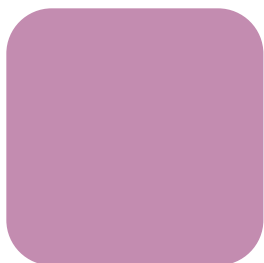

Filling water bottles, making salad rolls, line marking and putting up goal post padding. These are all run of the mill jobs for football and netball club volunteers. But boarding up windows to prevent netballers crashing through them? This is not a job you normally associate with club volunteers. But that's exactly what the volunteers of the Minyip Murtoa Football and Netball Club had to do.

Mr Storey conceded that the project could have been easier and a number of headaches could have been avoided had he sought the right advice from the outset. "Get good advice about what you are trying to achieve," said Brian. "Get advice from a professional who knows how to build a netball court rather than a road."

After: new asphalt playing surface with adequate run offs



Club Representative, Brian Storey, explains. "The netballers were playing 7 to 8 feet away from glass windows. Each game day the windows had to be boarded up so the girls wouldn't accidentally crash through them." This wasn't the last of the club's worries. The club's netball court was nearing the end of its useful life and large chunks of asphalt were breaking off the edges and cracks were appearing in the surface.

The club now enjoys a smooth even surface and the court run offs are now compliant, allowing the club to tender for finals. Importantly, the faithful Minyip Murtoa Football and Netball Club volunteers no longer need to spend their Saturday mornings boarding up the windows adjacent to the court and can devote their valuable time on other tasks around the club.

For more information contact Yarriambiack Shire Council on (03) 5398 0100.



The Yarriambiack Shire Council and the club planned to extend one side of the court thus allowing it to be shifted away from nearby obstructions. At the same time, the entire court would be resealed.

The old court was ripped up, however the base was not deep enough to lay the hot mix directly over the courts. The club arranged for more base rock to be applied so the hot mix could be laid. In doing so the court lost some of its fall to prevent water pooling and the problems with the club's court continued.

Tip:

- All courts must have adequate falls for surface drainage: minimum 1:100 fall in longitudinal and transverse directions to avoid pooling of water.
- Surface should be free from imperfections.

White Hills Football and Netball Club

Rectifying Proximity to Trees and Court Gradient



Club | White Hills Football and Netball Club
 Council | Greater Bendigo City Council
 Project Name | White Hills Football and Netball Club
 Redevelopment of Netball Courts
 CFNP Grant | \$20,000
 Total Project Cost | \$76,400 (2006)

Before: the substandard surface



The White Hills Football and Netball Club, located 5km north east of Bendigo, have experienced significant growth in recent years and currently have over 250 active members. Competing in the Heathcote and District Football and Netball League, White Hills Football and Netball Club has been an important part of the local community for 84 years.

The 'Hillies' had endured a substandard playing surface for many years with the existing facility unable to cope with demand. The existing courts were cracked from protruding tree roots and were visibly uneven, causing dangerous water pooling. These courts were not fenced, which made their proximity to a major road a concern. Club president, Bob Sawyer said, "The new courts are a fantastic boost to our club and have been much safer for all players and officials".

The redevelopment of the White Hills Football and Netball Club courts was rated as a high priority with the Greater Bendigo City Council's Sports Ground Improvement Strategy. Mark Powell, Recreation Liaison Officer at Greater Bendigo City Council said, "This project was certainly a priority for council as the existing courts were badly located, subject to fallen debris from nearby trees and the surface was clearly in poor condition."

In 2006, Greater Bendigo City Council was successful in receiving a \$20,000 grant, under the Victorian Government's *Country Football Netball Program*, to go towards the redevelopment of the White Hills Football and Netball Club netball courts.

The club contributed a significant \$26,400 through delivering phone books, selling recipe books and hosting a number of social functions. Council contributed a further \$30,000 toward the \$76,400 redevelopment.

The White Hills Football and Netball Club redevelopment provided two new compliant netball courts now safely located near the existing change rooms. The new courts were moved from the original location, away from any trees so they did not encounter the same problems with tree roots cracking the surface. The courts now have appropriate gradient so water pooling no longer occurs.

The new bitumen based surface was first used at the beginning of the 2007 season. Mark Powell says, "The courts were a great result for the community, they have greatly improved the safety for players and their proximity to the clubrooms brings the whole club together."

For more information contact Greater Bendigo City Council on (03) 5434 6000.

Tip:

- If there are trees near the facility, consider seeking expert advice about installing a root barrier that may protect the pavement from intrusion and cracking.
- Ideally, the court should be located a minimum distance of 7m from trees.

After: the new surface at White Hills FNC

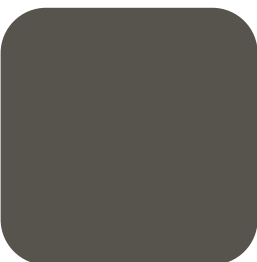

Myrtleford Saints Football and Netball Club

Multi-Purpose Courts



Club | Myrtleford Saints Football and Netball Club
 Council | Alpine Shire Council
 Project Name | RC McNamara Reserve Netball Court Upgrades
 CFNP Grant | \$50,000
 Total Project Cost | \$75,000 (2006)

After: the new courts in Myrtleford



In 2006, the netball courts at Myrtleford's RC McNamara Reserve underwent a significant surface upgrade.

RC McNamara Reserve is home to more than 130 netballers. The Saints have three teams that compete in the Ovens & Murray Netball Association. The Club also fields ten junior teams that play in the local league and runs a Net Set Go! junior development program for youngsters starting out in the sport.

Not surprisingly, the asphalt surface was tired and well worn. The deteriorating asphalt was gravelly and gritty to play on. Secretary of the RC McNamara Reserve Committee of Management, Marnie Broz, explained that, "The old courts represented a safety issue. It got to a stage where we were pushing it to use them. We would have to use a vacuum cleaner to blow the excess gravel off the courts before matches."

As a result, the Reserve Committee in partnership with council embarked on a project that involved redesigning and resurfacing the six existing netball courts at the RC McNamara Reserve facility. The old courts were revamped with a new asphalt hot mix surface. "The new surface is 100% better," says Ms Broz. "It is still asphalt, but it is smooth like fine bitumen on a road".

Importantly, multiuse line markings were incorporated into the plans so that both netball and tennis could be played. "The Committee were mindful of ensuring the courts stayed a community facility," explains Ms Broz. As a result, all courts were line-marked for netball and tennis with removable posts and the appropriate tennis post-hole caps to ensure a safe playing surface for all users.

Ms Broz stressed that, "it was important to oversee the works being done." She said it was imperative to double check that the multiuse line-markings were correct and the courts properly centred. Concreting and paving around the courts was included to improve accessibility and being a tennis facility, fencing was required. It was important that the fencing was located a sufficient distance from the courts to ensure minimum run-off was maintained.

Being a multipurpose facility means that the Myrtleford courts are better utilised by the community. Netball competitions run throughout winter and tennis holds court in the summer months.

The project has provided a safer playing environment for players, umpires, officials and volunteers that also encourages greater participation in physical activity across multiple sports, especially among women and young people.

For more information contact Alpine Shire Council on (03) 5755 0555.

Multi-purpose line markings



Tip:

Councils/Clubs should build in an annual surface replacement cost into their budgets so that financing of resurfacing is easily achieved (annual surface replacement costs for acrylic/cushioned acrylic and asphalt surfaces are approximately \$750-\$1000 per annum over 7-10 years). From time to time surfaces may need to be repaired from holes, nicks and cracks. These additional repairs need to be factored into ongoing operational costs.

Comparison of Different Playing Surfaces

The table below provides a summary of various playing surfaces that should be used to assist in planning your netball court development. Costings are current as at July 2008 and should be used as a guide only. Costings account for the construction of the court base and surface only and do not include site specific works such as earth works and drainage. There may also be other costs associated in obtaining relevant permits and approvals. The suitability of surface types for other sports intending to use the court should be considered in your planning.

Surface Type	Minimum Specification	Life Span	Qualities
Hot mix asphalt over asphalt base	<p>Ideally in well drained stable sandy soils:</p> <ul style="list-style-type: none"> • Minimum 100mm Class II crushed rock. • Minimum 30mm consolidated depth 7mm BC asphalt. 	<ul style="list-style-type: none"> • 15-20 years without a resheet. 	<p>Base</p> <ul style="list-style-type: none"> • Cost Effective. <p>Surface</p> <ul style="list-style-type: none"> • Good traction. • Low maintenance. • Cost Effective. • Can be surfaced with ac • Can be applied all year r
Acrylic over asphalt base	<p>Ideally in well drained stable sandy soils:</p> <ul style="list-style-type: none"> • Minimum 100mm Class II crushed rock. • Minimum 30mm consolidated depth 7mm BC asphalt. • Acrylic surfacing as per product specifications. 	<ul style="list-style-type: none"> • Asphalt base in good stable conditions – 40 years (Note the acrylic surface will protect the asphalt base from UV degradation and breakdown). • Acrylic Surface: 7 – 10 years. 	<p>Base</p> <ul style="list-style-type: none"> • Cost Effective. <p>Surface</p> <ul style="list-style-type: none"> • Looks good – can be ap colours. • Longevity – maintains its • Prolongs life of asphalt b degradation and weathe • Low maintenance. • Dries quickly after rain. • Improved player comfort temperature cooler in ho • Resurface in 7-10 years 80% of original surfacing

	Issues	Budget Costs (For One Court) – Inc GST
<p>acrylic material later in life. ground.</p>	<p>Base</p> <ul style="list-style-type: none"> • Suitability depends on outcome of soil tests prior to commencing project. Generally poor/reactive soil conditions dictate that an asphalt base is not suitable and/or cost effective. • Proximity of asphalt plant – asphalt must be laid hot. • Availability of suitably experienced local contractor. • Quality and source of Class II crushed rock. <p>Surface</p> <ul style="list-style-type: none"> • May become rough over time as a result of ultra violet breakdown of bitumen. • Proximity of asphalt plant – asphalt must be laid hot. • Availability of suitably experienced local contractor. • Quality and source of Class II crushed rock. 	<ul style="list-style-type: none"> • \$20,000 – \$25,000 (includes base and surface).
<p>applied in different s playability and feel. by preventing UV ring. c, some cushioning, court ot weather. will be approximately g costs (\$7,200).</p>	<p>Base</p> <ul style="list-style-type: none"> • Suitability depends on outcome of soil tests prior to commencing project. Generally poor/reactive soil conditions dictate that an asphalt base and acrylic surface is not suitable and/or cost effective. • Proximity of asphalt plant – asphalt must be laid hot. • Availability of suitably experienced local contractor. • Quality and source of Class II crushed rock. <p>Surface</p> <ul style="list-style-type: none"> • Consideration needs to be given to court gradient, maintenance regimes, recoating and player footwear to maintain good traction. • Best applied in the warmer months of the year. 	<ul style="list-style-type: none"> • Asphalt base: \$20,000 – \$25,000. • Acrylic surfacing: \$9,000.

Comparison of Different Playing Surfaces

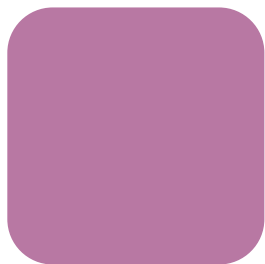
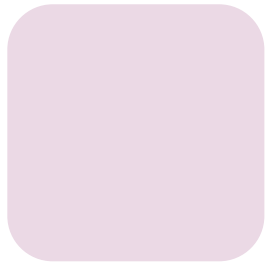

Surface Type	Minimum Specification	Life Span	Qualities
Acrylic over concrete base	<ul style="list-style-type: none"> Crushed rock bedding or sand 50-100mm thick. Full unperforated vapour barrier (to prevent moisture between the sub base and base). Minimum 100mm 25mpa concrete with low water/ cement ratio. Minimum F62 reinforcing mesh set on bar chairs. 	<ul style="list-style-type: none"> Concrete base: well constructed concrete – 40+ Years. Acrylic surface: 7-10 years. 	<p>Base</p> <ul style="list-style-type: none"> A concrete base court may be poor or reactive soil conditions. Can be surfaced with acrylics however will depend on soil conditions. <p>Surface</p> <ul style="list-style-type: none"> Looks good – can be applied to concrete. Longevity – maintains its appearance. Low maintenance. Dries quickly after rain. Improved player comfort and court temperature cooler in hot weather. Resurface in 7-10 years at 80% of original surfacing costs.
Cushioned acrylics over concrete or asphalt	<ul style="list-style-type: none"> As for concrete or asphalt bases. Adequate vapour barrier is essential for concrete. It is vital, particularly with cushioned acrylics, to have a high quality base surface. 	<ul style="list-style-type: none"> Asphalt or concrete – As per previous examples. 7–10 years before top colour coat needs rejuvenating. 	<p>Base</p> <ul style="list-style-type: none"> As per previous examples. <p>Surface</p> <ul style="list-style-type: none"> Long term Cushioned surfacing provides player comfort and reduces injury. Number of cushion layers depends on suit budgets. Longevity - maintains its appearance. Dries quickly after rain. Looks good - can be applied to concrete. Court temperature cooler in hot weather. Prolongs life of asphalt by reducing degradation and weathering. Low maintenance. Resurface in 7-10 years at 80% of colour surfacing costs (\$/sqm).

	Issues	Budget Costs (For One Court) – Inc GST
<p>may be better suited to conditions.</p> <p>acrylic at a later date, the condition of the base.</p> <p>plied in different colours. s playability and feel.</p> <p>, some cushioning, court ot weather.</p> <p>will be approximately g costs (\$7,200).</p>	<p>Base</p> <ul style="list-style-type: none"> • If base is poorly constructed it is difficult to repair. • Availability of suitably experienced local contractor. <p>Surface</p> <ul style="list-style-type: none"> • Consideration needs to be given to court gradient, maintenance regimes, recoating and player footwear to maintain good traction. • Best applied in the warmer months of the year. 	<ul style="list-style-type: none"> • Concrete surface: \$40,000 – \$50,000. • Acrylic surfacing: \$9,000.
<p>es.</p> <p>urface providing maximum ces leg fatigue.</p> <p>s can be customised to</p> <p>playability and feel.</p> <p>plied in different colours.</p> <p>er in hot weather.</p> <p>y preventing UV rring.</p> <p>will be 80% of original (\$7,200).</p>	<p>Base</p> <ul style="list-style-type: none"> • As per previous examples. <p>Surface</p> <ul style="list-style-type: none"> • Consideration needs to be given to court gradient, maintenance regimes, recoating and player footwear to maintain good traction. • Best applied in the warmer months of the year. 	<ul style="list-style-type: none"> • Concrete or asphalt base as per previous examples: \$20,000 – \$50,000. • Cushioned acrylics: \$20,000 – \$30,000 (for full layering system – please refer to diagram below. Application of fewer layers can be negotiated to suit financial circumstances).

Example cushioned acrylic layering system

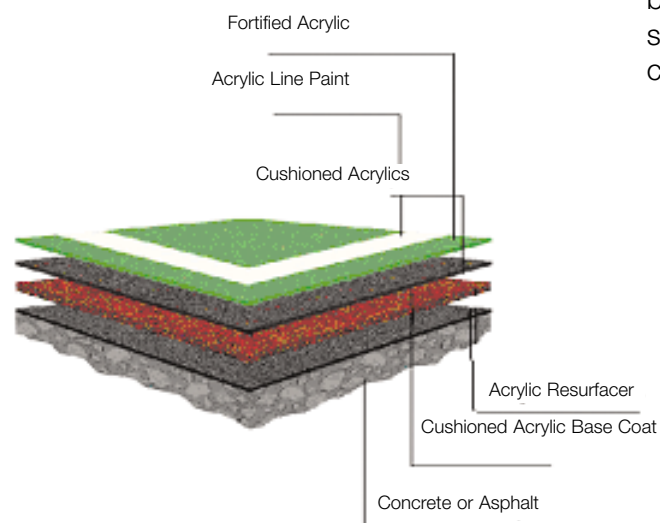

Netball Court Development – The Planning Process

Consultation

Prior to undertaking a netball court development or upgrade, it is vital that appropriate consultation is undertaken. It is necessary to discuss project ideas with the relevant, Recreation Reserve/Venue Authority to determine how the project fits with current and future land use planning. Council may be able to provide advice regarding how the development links with relevant reserve master plans and or council recreation strategies. Projects should also be discussed with other reserve users and relevant netball leagues, associations and Netball Victoria to gain their support for the development/upgrade.

Planning Approach

Local government statutory planners will be able to provide advice on property development and land use proposals in accordance with the *Planning and Environment (Planning Schemes) Act 1996*.

Planning schemes set out policies and provisions for the use, development and protection of land for an area. Each municipality in Victoria is covered by a planning scheme. Zones reflect the primary character of land, such as residential, recreational, industrial or rural, and indicate the type of use which may be appropriate in that zone. A planning permit is a legal document that allows a certain use or development to proceed on a specified parcel of land.

Planning Permits

A planning permit is a statement that a particular use or development (subdivision, buildings, and works) may proceed on a specified parcel of land. Sometimes a permit is specific to a nominated person or operator. It is always subject to a time limit and will expire under specified circumstances. The responsible authority is entitled to impose conditions when granting a permit.

If you propose to use or develop land, first discuss the proposal in detail with your local council planning officer. Early discussion will confirm whether a planning permit is necessary and highlight likely requirements.

The planning permit process may also include consultation with surrounding residents and other stakeholders.

It is important not to confuse planning permits with building permits. Building permits relate to the method of construction of a building or development. A planning permit does not remove the need to obtain a building permit.

The best way to find out whether you need a planning permit is to contact the planning department of your local council as the council is typically the responsible authority for deciding permit applications.

Building Permits

Netball court light pole installations and associated infrastructure such as shelters, may require a building permit, irrespective of whether a planning permit is also required. Further information about the building permit process can be obtained from the building department of your local council.

If your court development involves the installation of netball court lighting, please be aware that lighting must comply with Australian Standards for outdoor netball (series 2560.4) Should you require further information regarding netball lighting please refer to the Victorian Government's *Football and Netball Lighting Guide*.

Netball Court Development – Construction and Maintenance

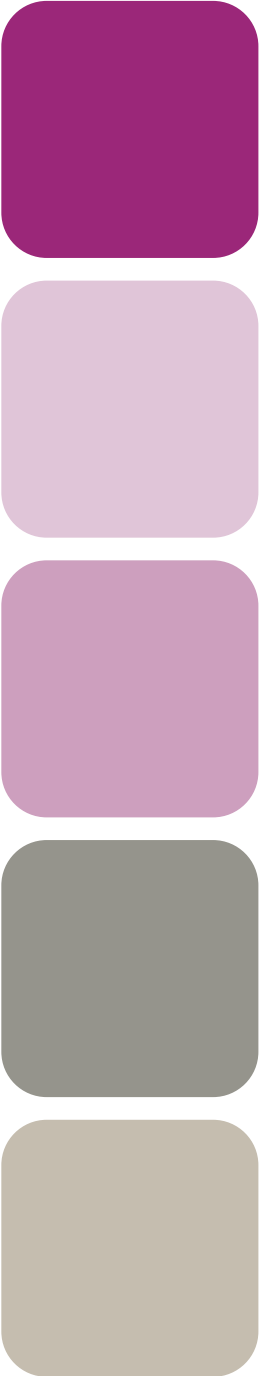

Some of the information outlined below is technical in nature. The information is provided to make the reader aware of court development, upgrade and maintenance requirements and may be passed onto a suitably qualified tradesperson who will then be able to plan for your project proposal needs.

Items to Consider When Constructing Concrete Bases

- It is essential to have a good understanding of soil conditions prior to court construction to determine correct court construction requirements. Soil tests should be carried out by a recognised Geo technical company;
- All courts must have adequate falls for surface drainage: minimum 1:100 fall in longitudinal and transverse directions;
- The concrete pavement is to be constructed to a standard suitable for surfacing with acrylic; and
- The following construction details should be adhered to:
 - Adequate sub-soil and perimeter drainage is a pre-requisite to ensure ground moisture is prevented from entering the concrete slab;
 - A waterproofing membrane consisting of a P.V.C. building film is to be installed under the concrete. This should not be perforated at any stage;
 - Placing tension releasing cuts in the slab so that cracking is controlled should be done within 24-48 hours of pouring to minimise hair-line cracking;

- Given stable ground conditions, it is recommended that a 100mm thick 25 mpa concrete slab, reinforced with F-62 mesh set on bar chairs be used;
- Chemical waterproofing compounds should not be incorporated in the concrete mix;
- Chemical curing compounds should not be used; and
- The concrete should be finished with a wooden float followed by a broom drawn lightly across the surface. Care is to be taken that no ridges are left on the surface.

Maintenance Program for Acrylic Surface Courts

It is critical to ensure ongoing care and maintenance to prolong the life of your playing surface.

- Do not permit chairs on the court surface unless they are placed on a timber base to distribute point loads;
- Wire or hair door mats should be placed at all entry points to prevent dirt and other foreign materials being carried onto the court surface;
- Leaves and other debris should be swept up and removed from the court area regularly. If allowed to decompose they will stain the court surface and lead to the development of black mould spots;
- Tree branches, grass and shrubs around the perimeter of courts should be cut regularly, or poisoned, to prevent encroachment onto the court surface. Ideally, the court should be located a minimum distance of 7m from trees;

Netball Court Development – Construction and Maintenance

Maintenance Program for Acrylic Surface Courts (cont.)

- If possible hose down your courts regularly to remove any surface dirt which has been deposited from the atmosphere. Please note that surface dirt is more likely to occur in low spots or in shaded areas and particular attention should be paid to these areas of the court. A household detergent and medium grade yard broom should be used in conjunction with hosing to disturb and dislodge black mould build up. NB: check current water restrictions with your local water authority to determine if or when hosing can occur;
- Bird droppings and staining from trees can be treated with normal domestic detergents. For more persistent stains treat with a bleach solution. Dilute as per product instructions;
- For mould, apply solution to mould spot and scrub lightly with stiff hand brush or stiff bristle broom. Leave solution on surface for 10-15 minutes, then hose off. Repeat this procedure again if mould still persists. Follow product safety information when using bleach solution;
- When using a high pressure water jet to clean courts, a minimum pressure of 2000psi should be used with the wand tip approximately 300mm above the court surface. The operator must take care and adjust the process if the water jetting is damaging the surface; and
- No vehicular traffic should be permitted on the court surface. If this is unavoidable all traffic must be restricted to the outer reaches of the court where the cushion surface is at its least. Under no circumstances should any vehicle utilise power steering on any one point on the court surface.

Repair Procedures for Acrylic Surface Courts

- All holes, nicks and cracks to be repaired with a filler material that should be dry, clean and free from loose dirt, dust, greases and oils;
- Using a hand trowel, apply a small amount of the filler material into the hole and feather out the edges, removing any excess material. Allow this to set for at least 24 hours. Do not apply in thickness greater than 3mm per coat; and
- Do not apply filler material when rain is imminent, or when temperature is below 10 degrees.

Netball Court Specifications

Orientation

A North – South court orientation is preferred to minimise the effects of sun glare.

Court Size

As Netball Victoria is a State Member Organisation of Netball Australia, Netball Australia’s guidelines are followed. The court measurements outlined below form part of the current Official Rules of the International Federation of Netball Associations (2001) in which Netball Australia is a member.

The Court should have a firm surface, and its measurements are:

- Side Lines 30.5 metres (100 feet)
- Goal Lines 15.25 metres (50 feet)
- Goal Circle 4.90 metres (16 feet) (radius)
- Centre Circle 0.90 metres (3 feet) (diameter)
- Width of Court Lines 50 mm (2 inches)
- Gradient 1% cross fall both directions

Court Layout

The diagrams below provide an indication of various court layouts that may be used to assist in planning your netball court development. They should be used as a guide only and professional advice should be sought before confirming layout.

One Court Layout – with shelters and lighting

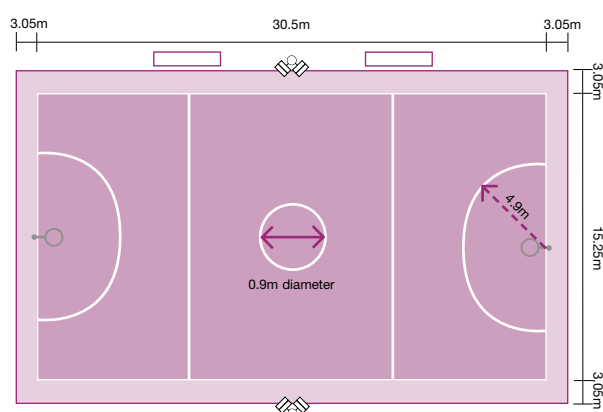

Two Court Layout – with shelters and lighting

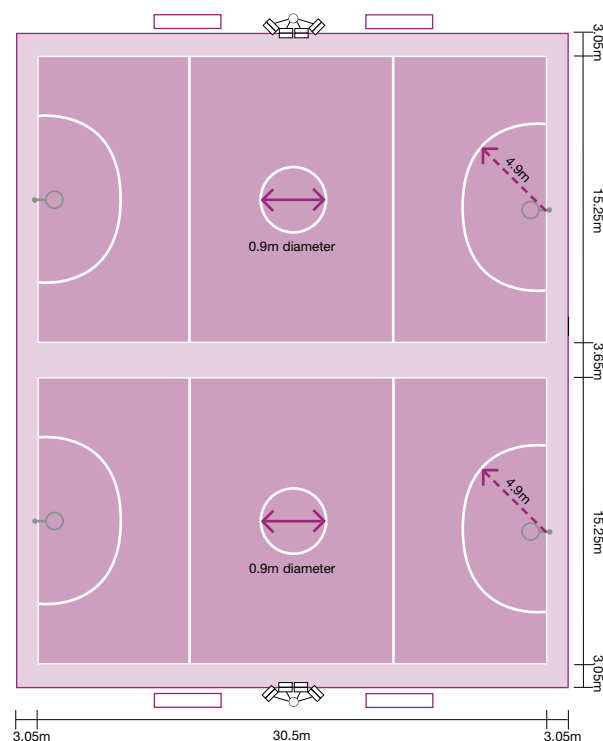

Netball Court Specifications

Four Court Layout - with shelters and lighting

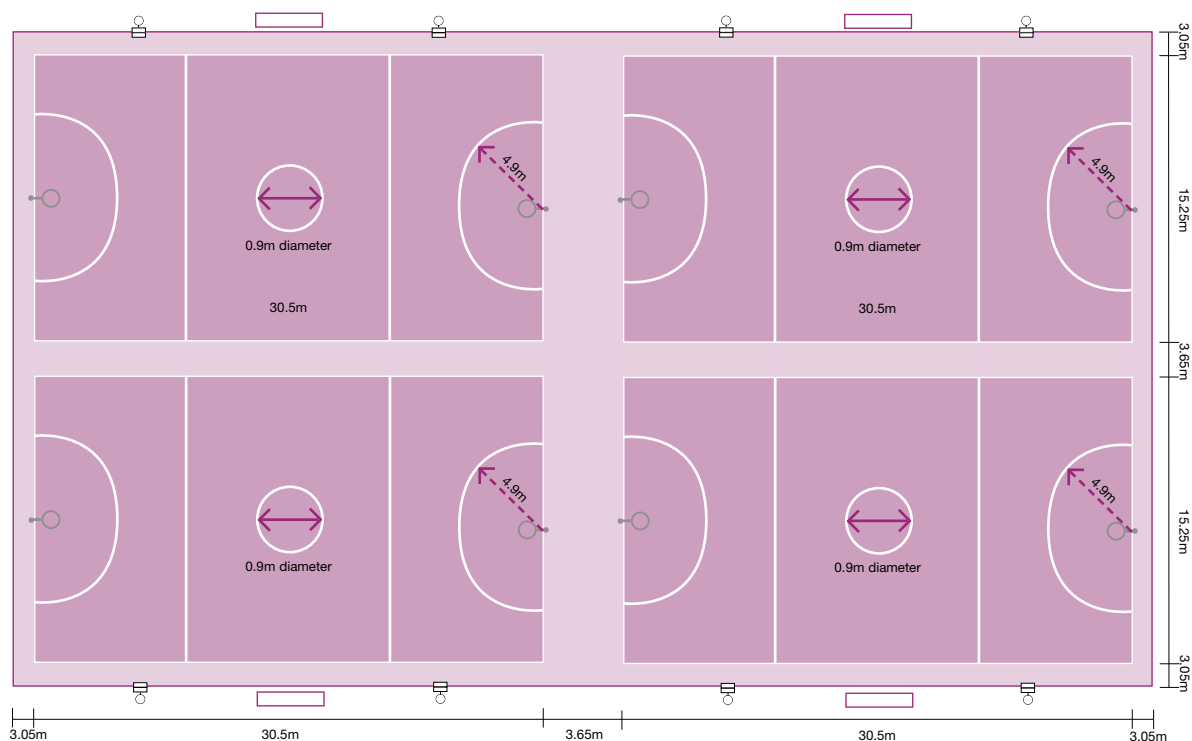

Run Off

The 3.05m run off clear space, **of the same surface as the court**, outside each side line and end line, is an International Federation of Netball Association guideline adopted by Netball Australia to ensure safety of players and umpires.

Unlike sports such as basketball and football, netball umpires officiate outside the court boundaries. To ensure that the umpires can safely run around the outside of the court as well as providing a run-off space for players, courts must have a 3.05m area (same surface material as the playing area) around the court perimeter. This space must be clear of obstructions including seating, fencing and light poles.

- Goal lines 3.05m
- To walls/seating/shelters 3.05m
- In between courts 3.65m

Goal Posts

- Vertical Height 3.05 metres
- Thickness:
 - (i) in diameter 65 mm
 - (ii) square 65 mm
- The back of the goalpost should be placed on the outer edge of the goal line.
- The post may be inserted in a socket in the ground or may be supported by a metal base that shall not impede onto the court.
- Normally painted white.

Netball Court Specifications

Figure 2

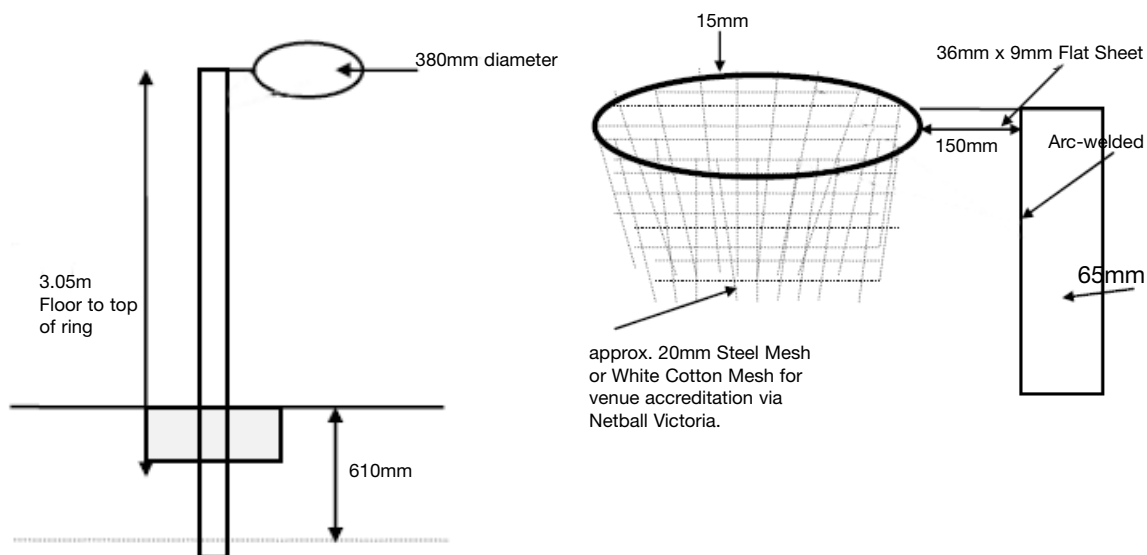

Goal Rings

- Ring (internal diameter) 380 mm
- Attachment connecting ring to post 150 mm
- Ring thickness 15 mm
- Fitted with a net open at both ends

Net Post Footings for Fixed or Sleeved Posts

The concrete base should be poured using job mixed concrete; i.e. crushed rock, sand and cement, or plant mixed concrete.

Tip:

DO NOT USE rapid-set concrete as this has a tendency to rise out of the ground with the sleeve and/or post.

Netball Court Specifications

Insert Socket Specifications

a) Goalpost Insertion

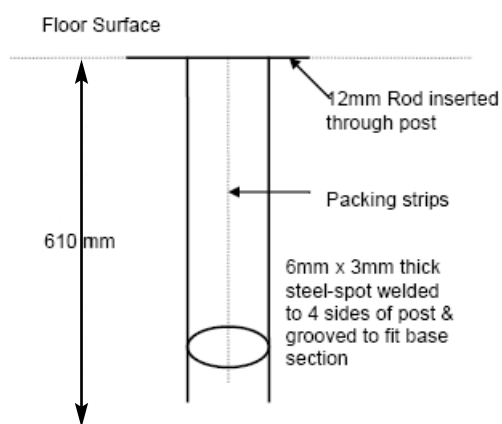

b) Goalpost socket in concrete base

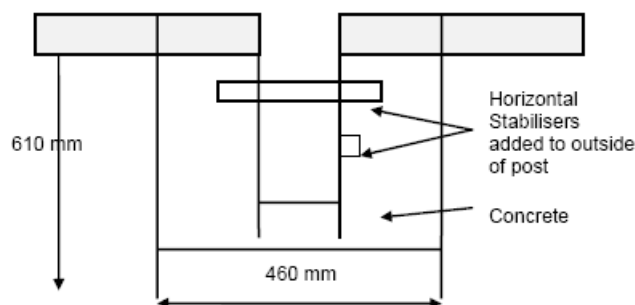

The packing strips on the base section of the goalpost are spot welded and ground to make a reasonably tight fit to the opening in the concrete. There are stabiliser bars attached horizontally across the pipe to stop any movement and, a cut out on the top of the pipe into which the goalpost slots. See Fig. (a). (above)

The Concrete base should be 460mm x 460mm x 610mm deep. See Fig. (b) (above). After slab and floors have been fitted, the goalpost is then placed into position to ascertain the 3.05m height.

The top of the post should be steel capped, and not project above the height of the ring. The ring is constructed of 15mm steel and has welded to its lower rim edge 12 small steel loops to which the chain mesh is welded. A strong white string net, or a chain mesh net is to be attached.

The ring is welded to the post as shown Fig. 2 (previous page).

The goalposts are normally painted white and for training and match play must be padded the entire length of the post.

Padding

Padding should not be more than 50mm thick and shall start at the base of the goalpost and extend the full length of the goalpost (3.05m). NB: Associations that have goalpost pads that meet the previous requirements of between 2 metres and 2.5 metres up the goal post, should purchase full-length pads when replacing them.

Netball Court Specifications

Linemarking

- Allow new asphalt pavements to cure for 7-10 days prior to line marking;
- Do not use oil based line paint to mark new or re-line the existing court pavements as they can become slippery when wet and the paint will crack;
- Use water based outdoor acrylic line paint (good quality); and
- Apply in thin layers – do not put heavy coats leading to build up over the asphalt as this will also crack and curl along the sides.





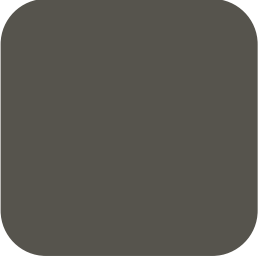

Indoor Netball Court Development

Councils who are considering an indoor netball court development are encouraged to seek professional advice when planning for the project. Netball Victoria are able to provide advice and guidance regarding indoor court developments.

Checklist



Prior to undertaking a netball court development or upgrade, please ensure that you have:

- Considered how the development links with relevant reserve master plans and/or council recreation strategies.
 - Discussed the project proposal in detail with your local council planning officer and obtained the relevant permits and recreation reserve/venue authority approvals.
 - Considered how the chosen surface, line marking and associated infrastructure meet the requirements of other sports intending to use the court and relevant standards.
 - Considered the layout of associated netball infrastructure for current and future requirements.
 - Discussed the project proposal in detail with your local netball league/association.
 - A good understanding of soil conditions to determine correct court construction requirements. Soil tests should be carried out by a recognised Geo technical company. If upgrading an existing court, engage an appropriately qualified person to determine current court profile and requirements of an upgrade.
 - With consideration to soil test results, agree on the intended court type with all user groups including the anticipated costs and ongoing maintenance considerations.
- 
- 
- 
- 

Acknowledgements



The Netball Court Planning Guide has been developed in collaboration with a number of stakeholders.

Special thanks to Netball Victoria and WM Loud for providing expert advice and technical content.

The contribution of the following organisations is gratefully acknowledged:

- 
- 
- Alpine Shire Council
 - Colac Otway Shire Council
 - Greater Bendigo City Council
 - Murrindindi Shire Council
 - Yarriambiack Shire Council
 - Minyip Murtoa Football and Netball Club
 - Myrtleford Football and Netball Club
 - South Colac Sports Club
 - White Hills Football and Netball Club
 - Yea Football and Netball Club



For further information regarding netball court development, please see Netball Victoria's website www.netballvic.com.au or contact Netball Victoria on (03) 9321 2222.

This resource contains comments of a general nature only and is not intended to be relied upon as a substitute for professional advice. No responsibility will be accepted by the Department of Planning and Community Development for loss occasioned to any person doing anything as a result of any material in this resource.

Any opinions, findings, conclusions or recommendations expressed herein are guidelines only and should not be expressly relied on by project proponents.

Published by Sport and Recreation Victoria
Department of Planning and Community Development
1 Spring Street
Melbourne Victoria 3000

Telephone (03) 9208 3333

September 2008

© Copyright State Government of Victoria 2008
This publication is copyright. No part may be reproduced by any process except in accordance with the provisions of the Copyright Act 1968.

Authorised by James Merlino MP
Minister for Sport, Recreation and Youth Affairs
1 Spring Street, Melbourne.

Printed by Red Rover
53 Brady Street
South Melbourne Vic 3205

Printed on 80% recycled paper

If you would like to receive this publication in an accessible format, such as large print or audio, please telephone (03) 9208 3333, or email info@sport.vic.gov.au

This publication is also published in PDF and Word formats on www.dpcd.vic.gov.au

